



GRU AUTOMONTANTI IDRAULICHE
SELF ERECTING CRANES
GRUES MONTAGE RAPIDE
SELBSTMONTIERENDE HYDRAULIKKRÄNE
КРАНЫ ГИДРАВЛИЧЕСКИЕ САМОМОНТИРУЮЩИЕСЯ

CE  L_{WA}
97 dB
H1B3-DIN15018
CRANES
SELF
TOWERS **VICARIO**





CONFIGURAZIONE - REAZIONI - HR33

CONFIGURATION - REACTIONS / CONFIGURATION - RÉACTIONS / KONFIGURAZION – REAKTIONEN /
 КОНФИГУРАЦИЯ КРАНА

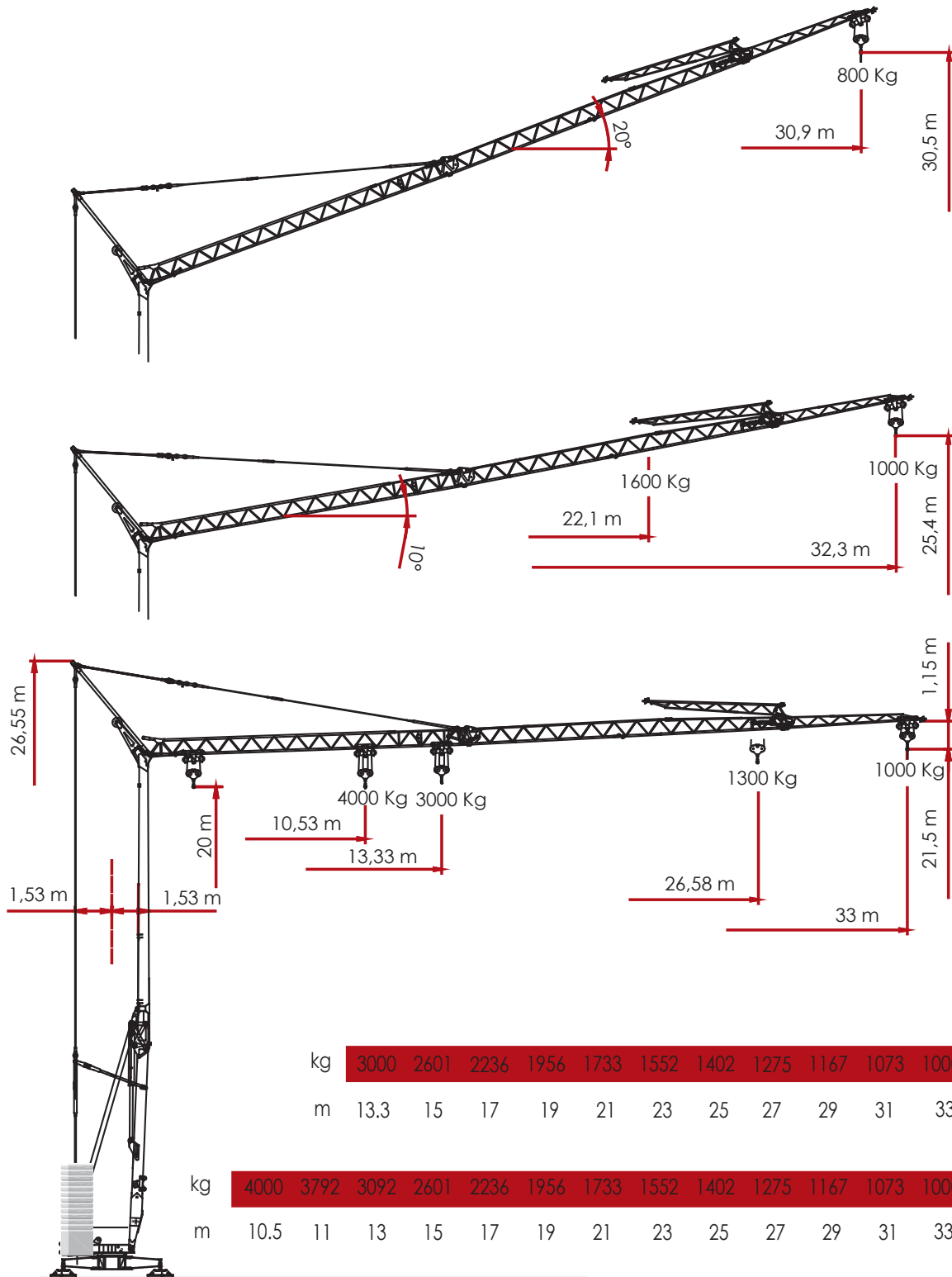

CARATTERISTICHE AZIONAMENTI PRINCIPALI

MAIN DRIVE CHARACTERISTICS / CARACTÉRISTIQUES ACTIONNEMENTS PRINCIPAUX / HAUPTBEDIENUNGSEIGENSCHAFTEN / ХАРАКТЕРИСТИКА ГЛАВНЫХ ПРИВОДОВ

 400 V (+10% - 10%) 50 Hz 12 kVA

	▶	▶▶	▶▶▶	▶▶▶▶
m/l'	8	20	46	56
kg	3000	3000	1200	800
kW	11 (Inverter)			

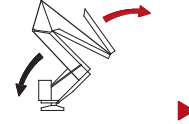

min 14
kW 3

	▶	▶▶	▶▶▶	▶▶▶▶
m/l'	8 - 4	20 - 10	46 - 23	56 - 28
kg	2000 - 4000	2000 - 4000	1200 - 2400	800 - 1600
kW	11 (Inverter)			

	▶	▶▶	▶▶▶
g/l'	17.3	28.6	53.5 (↗ 39.3)
kW	3 (Inverter)		

	▶	▶▶	▶▶▶
m/l'	0.17	0.43	0.85
kW	3 (Inverter)		

	14.280 Kg.	5.200 Kg. + 16.900 Kg.
--	------------	------------------------

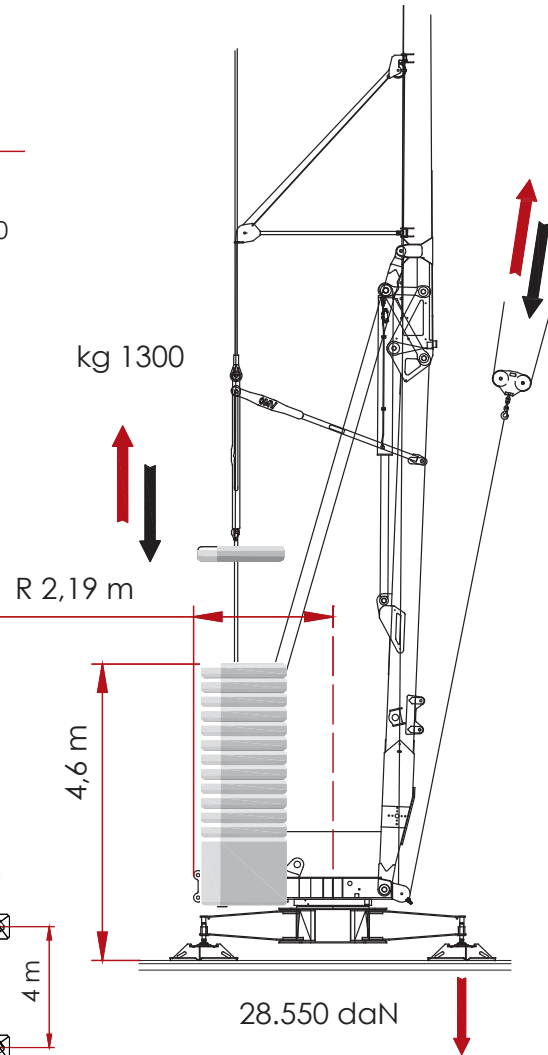
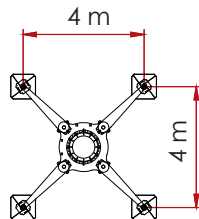

F [daN]

SFORZI MASSIMI
AL PIEDE

MAX STRESSES
AT THE FOOT

EFFORTS MAX.
AU PIED

MAX. BEANSPRU
CHUNG AM FUSS

МАКС. УСИЛИЯ НА
ПОДНОЖИЕ



SEQUENZA DI MONTAGGIO SU 360°

ERECTION PROCEDURE ON 360° / DÉRULEMENT DE MONTAGE SUR 360° / AUFSTELLVORGANG UBER 360° / ХАРАКТЕРИСТИКА ГЛАВНЫХ ПРИВОДОВ

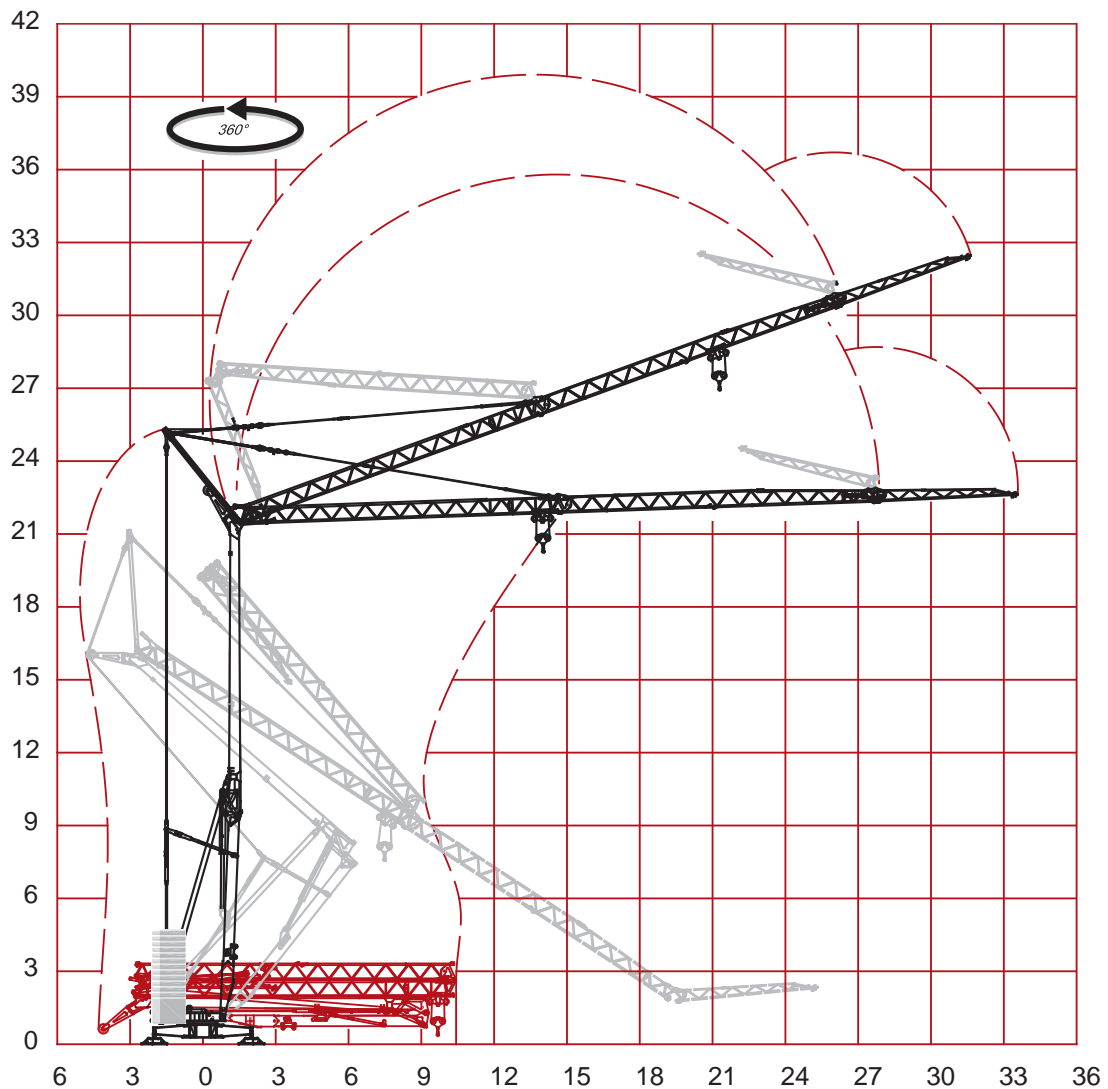

GRU AUTOMONTANTI IDRAULICHE

SELF ERECTING
CRANESGRUES MONTAGE
RAPIDESELBSTMONTIRENDE
HYDRAULIKKRÄNEКРАНЫ ГИДРАВЛИЧЕСКИЕ
САМОМОНТИРУЮЩИЕСЯ

SOLUZIONE DI TRAINO

TRACK LOAD PLAN / PLAN DE CHARGEMENT / SCHLEPPLÖSUNG / ВАРИАНТ БУКСИРОВКИ

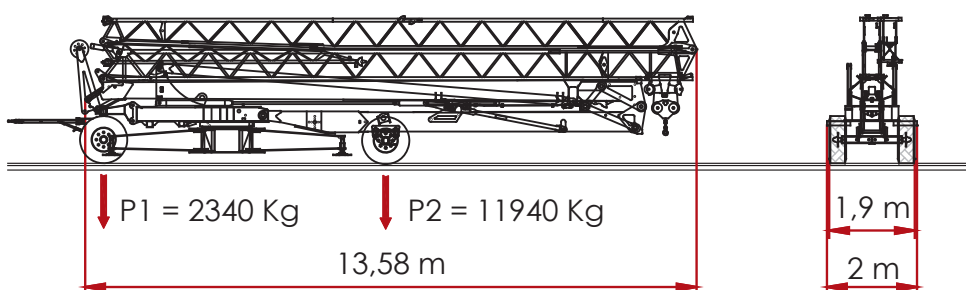
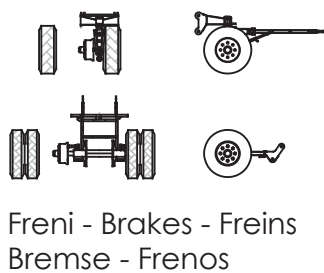
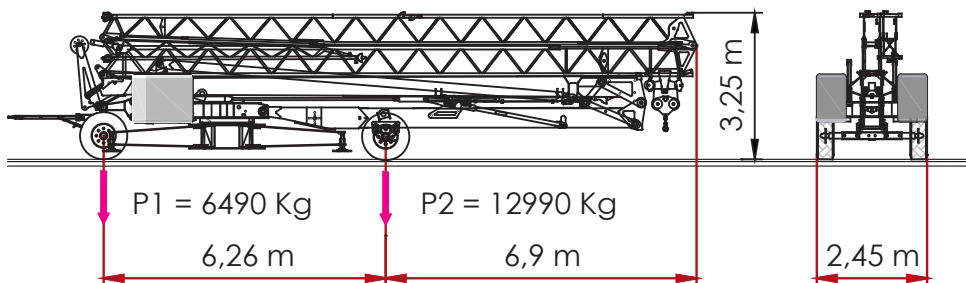
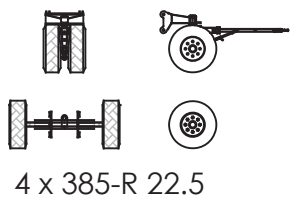

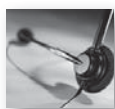

INFO

RAIMONDICRANES S.p.A.
CORSO GARIBALDI n° 253
20025 LEGNANO [MI] - ITALY



PROJECT

☎ 0039. 0331.548061
📠 0039. 0331.450400



S.A.T.

☎ 0039.0331.548061.258



www.raimondicranes.com
info@raimondicranes.com

HR 33 [REV. 00.2010] ADL / TECHNICAL DEPARTEMENT
I DATI OGGETTO DELLA PRESENTE SCHEDA POTREBBERO
SUBIRE MODIFICHE SENZA PREAVVISO

DISTRIBUTORE .DEALER .DISTRIBUTEUR .VERTEILER .ДИЛЕР



RAIMONDI CRANES
Building Tower Cranes Since 1946